



12V20Ah

Multi-application LiFePO4 Power

Features & Dimension

Bluetooth



- Support Bluetooth (optional extended function)
- Quick recharge
- High consistency
- No memory effect
- Low self-discharge
- High rate discharge
- Super long cycle life
- Environment-friendly
- Low internal resistance
- Replace lead-acid battery

AWILCO smart battery APP version 1.0 on Android and IOS, run with Bluetooth to get the working specification of the battery easily.

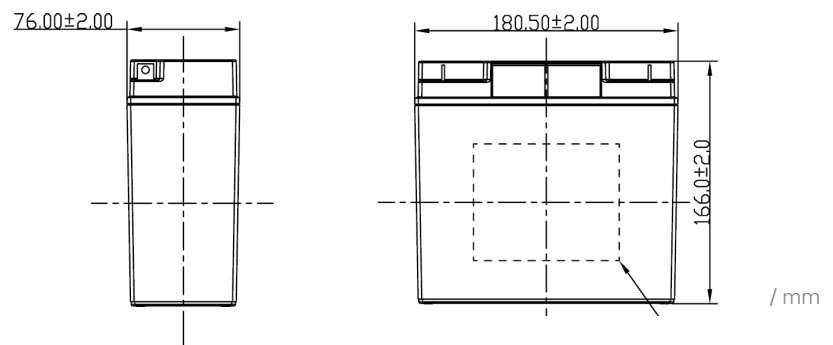

Specification

Model	LFP12020B
Nominal voltage	12.8V
Typical capacity	20Ah
Internal impedance	≤60mΩ
Max charge voltage	14.6±0.1V
Cut-off discharge voltage	≤10V
Max continuous charge current	20A
BMS / PCM	20A
Pulse discharge current (2s)	55A
Terminal Type	M6
Battery Case Type	ABS
Work Temperature	-20°C ~ 55°C
Weight (approx.)	3.00Kg
Dimension (approx.)	180 x 75 x 170mm
Support Bluetooth or not	Yes