

AWILCO

FERNBEDIENUNG FÜR WECHSELRICHTER 1000W / 2000W / 3000W

AW30010001

BEDIENUNGSANLEITUNG



Bitte lesen Sie die gesamte Bedienungsanleitung sorgfältig durch bevor Sie das Energiesystem verwenden. Missbrauch kann zu Schäden am Gerät führen und / oder Schäden oder schwere Verletzungen verursachen.

KUNDENDIENST

E-mail: mail@awilco.de

Telefon: +45 56 56 54 00

Website: awilco.de

**BITTE BEWAHREN SIE DIESE
BEDIENUNGSANLEITUNG ZUM
SPÄTEREN NACHSCHLAGEN AUF**

 **AWILCO**
FLEXIBLE POWER SOLUTIONS

WARNING

Read all instructions before operating. Failure to follow all instructions may result in electric shock, fire and/or serious injury.

- **AVOID DANGEROUS ENVIRONMENTS.** Don't use in damp or wet locations.
- **KEEP CHILDREN AWAY.** Keep away from children. This is not a toy!
- **STORE INDOORS.** When not in use, your remote should be stored indoors in dry, and high or locked-up places - out of reach of children.
- **DON'T ABUSE CORD.** Never carry your remote by cord or yank the cord to disconnect from receptacle. Keep cord from heat, oil, and sharp edges.
- **DISCONNECT.** Disconnect from the power supply when not in use.
- **PROPER COOLING** is essential when operating. Do not place it near a vehicle's heat vent or in direct sunlight.
- **USE OF ACCESSORIES AND ATTACHMENTS.** The use of any accessory or attachment not recommended by Manufacturer.
- **STAY ALERT.** Use common sense. Do not operate when you are tired.
- **CHECK FOR DAMAGED PARTS.** Any part that is damaged should be properly repaired or replaced by an authorized service center.
- **DO NOT OPERATE** near flammable liquids or in gaseous or explosive atmospheres. Motors in tools or appliances used with the inverter may spark, and the sparks might ignite fumes.

FUNCTION DESCRIPTION DRAWING

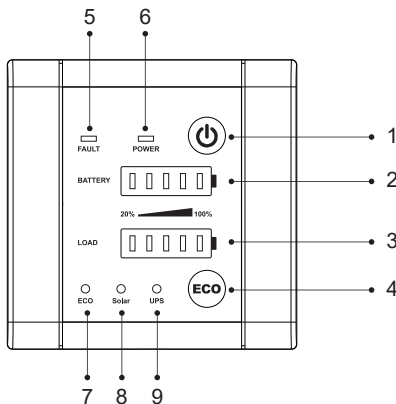

- | | |
|---|--|
| 1. ON/OFF Switch/ Sleep Switch | 6. ON/OFF status indicator of inverter |
| 2. Battery voltage status indicator | 7. "ECO" status indicator |
| 3. LOAD status indicator/ Fault indicator | 8. Solar input indicator |
| 4. ON/OFF switch of "ECO" mode | 9. UPS mode Indicator |
| 5. Fault indicator | |

INSTALLATION

1. Mount the Remote

There are two ways to mount the Remote.

① If there is 86 type bottom box in the vehicle

- Use crowbar or screwdriver to separate the front plate of the Remote from its main body.
- Align the mounting holes on the middle of main body with the holes on 86 type bottom box. Fix the main body with included screws.
- Reattach the front plate to the main body.

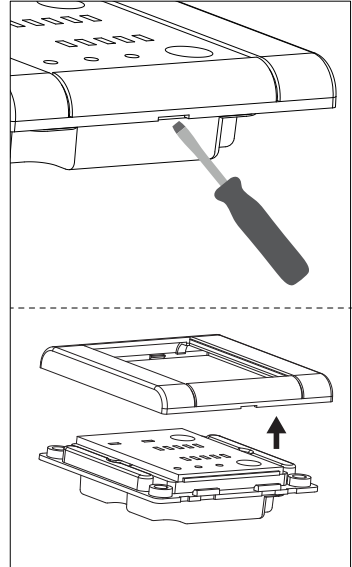

② If there is no 86 type bottom box in the vehicle

- Use crowbar or screwdriver to separate the front plate of the Remote from its main body.
- Use the main body as a template to mark four screw holes with a pencil.
- Pre-drill four screw holes on the mounting surface with a drill.
- Align the mounting holes on the corners of main body with the pre-drilled screw holes. Fix the main body with included screws.
- Reattach the front plate to the main body.

2. Connection

Connect one end of the included RJ-type cable into the Remote Port on the side of your Inverter. Connect the other end into the cable interface of the Remote.

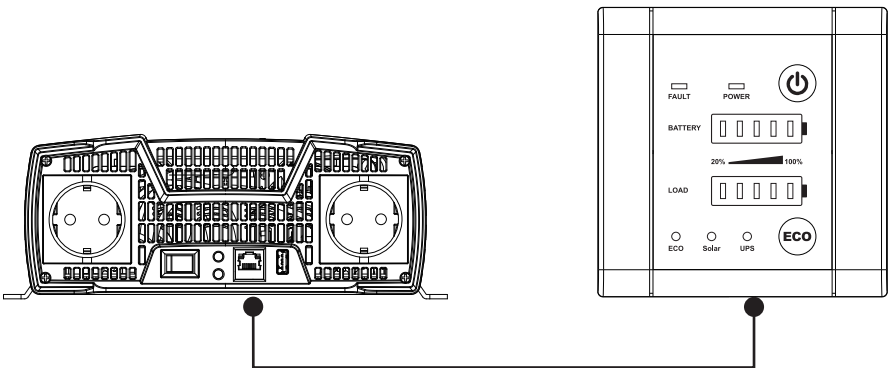

OPERATION

ON/OFF switch is used to turn on or turn off the inverter.

If the inverter is already turned on, Remote will be turned on automatically after connection; If the inverter is originally closed, then after connection, long press the ON/OFF button to turn on the inverter and all the indicators light up for 3 seconds.

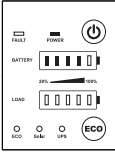
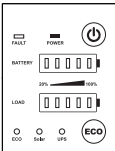
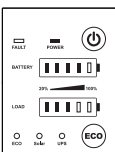
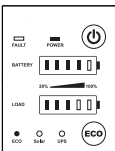
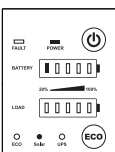
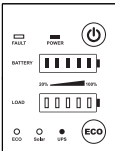
	<p>After 3 seconds, the "ON" LED and "BATTERY" LEDs still light up. The "ON" LED indicates that the inverter has been turned on. The "BATTERY" LEDs show the approximate battery voltage of your connected battery.</p>
	<p>Press the ON/OFF button shortly and the remote enters sleep mode. Sleep mode: Only the "POWER" LED light up, and other LEDs go out.</p>
	<p>When electrical appliances are connected to inverter, the "LOAD" LEDs show the approximate power of your appliances and the "BATTERY" LEDs show the approximate power of the connected battery.</p>
	<p>Press "ECO" button shortly to enter ECO mode and the "ECO" indicator lights up. When the inverter is in ECO mode and the power of connected appliances is under 50W, the inverter will stop output and wait for next period of pulse; and when the power of connected appliances becomes over 50W, the inverter will start to output automatically.</p>
	<p>When the connected battery is charged by solar panel, the "SOLAR" LED lights up and the "BATTERY" LEDs show the charging status of the battery.</p>
	<p>When the connected electrical appliances are powered by mains supply, "UPS" LED lights up and the "BATTERY" LED indicates the voltage status of the connected battery.</p>

REFERENCE:

1. Indicated input voltage range of “Battery” LEDs:

- ① Input voltage range: 10.50~11.20V, the LEDs indicate 20%.
- ② Input voltage range: 11.20~11.85V, the LEDs indicate 40%.
- ③ Input voltage range: 11.85~12.30V, the LEDs indicate 60%.
- ④ Input voltage range: 12.30~12.80V, the LEDs indicate 80%.
- ⑤ Input voltage range: above 12.30V, the LEDs indicate 100%.

2. Indicated electrical appliances power of “LOAD” LEDs:

- ① Power of all the connected electrical appliances: <400W, the indicators don't light up.
- ② Power of all the connected electrical appliances: 400~800W, the LEDs indicate 20%.
- ③ Power of all the connected electrical appliances: 800~1200W, the LEDs indicate 40%.
- ④ Power of all the connected electrical appliances: 1200~1600W, the LEDs indicate 60%.
- ⑤ Power of all the connected electrical appliances: 1600~2000W, the LEDs indicate 80%.
- ⑥ Power of all the connected electrical appliances: >2000W, the LEDs indicate 100%.

TROUBLE SHOOTING

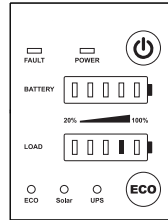
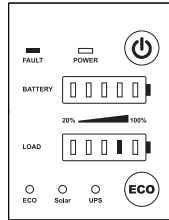

Indicaton	Fault	Correction
The 1st “LOAD” indicator lights up and “FAULT” LED flashes	Input voltage <10.5v or >15.5v	The inverter will beep-alarm and stop output, and take 1 minute to detect voltage to check if it has reached threshold voltage for automatic recovery: When threshold voltage >12.0V: The inverter will automatically recover from under-voltage protection. When threshold voltage <14.5V: The inverter will automatically recover from over-voltage protection.
the 2nd “LOAD” indicator lights up and “FAULT” LED flashes	AC Output short circuit	Unplug and check your appliances, then restart your inverter manually

Indicaton	Fault	Correction
The 3rd "LOAD" indicator lights up and "FAULT" LED flashes	Over-temperature. The fans malfunction or ambient temperature is over 60°C	Turn off the inverter and unplug your appliances. Leave the inverter for cooling and wait until the temp below 60°C, then restart your inverter manually
The 4th "LOAD" indicator lights up and "FAULT" LED flashes	Over-load	Please unplug and check your appliance, then restart your inverter manually
The 5th "LOAD" indicator lights up and "FAULT" LED flashes	Internal error	Mostly, restarting could solve this problem; if not, please consult and send it back to your licensed dealer/retailer for any repairs or spare parts services.

SPECIFICATION

Model	30.01.0001
DC Input Voltage Range	7-18V
Working current	10mA
Shutdown current	8mA
Sleeping current	9mA
Supplied cable	RJ12 interface for 1000W inverter, 5m, RJ45 interface for 2000W inverter, 5m
Working Temperature Range	-20~50°C
Dimensions	86 x 86 x 22.5mm
Weights	70g
IP Rating	IP22



AWILCO

FLEXIBLE POWER SOLUTIONS